

PT5600

Cable Actuated Sensor Industrial Grade • Cable Reel

Absolute Linear Position to 250 inches (6350 mm)

Hard Anodized Aluminum Enclosure

Converts Virtually Any Encoder to a Linear Position Sensor

Available With or Without Encoder

General

Full Stroke Range	0-50 to 0-250 inches
Motion Conversion Ratio	8 inches per turn, see ordering information
Accuracy	the lesser of 0.02% full stroke or 0.04% of measurement range
Measuring Cable	stainless steel or thermoplastic
Module Material	hard anodized aluminum
Weight	5 lbs., max

Environmental

Operating Temperature	-40° to 200°F (-40° to 90°C)
------------------------------	---------------------------------

Our unique linear-to-rotational, industrial-grade string encoder module mates to virtually any encoder, giving you a cost-effective linear position measurement solution that precisely fits your requirements. The PT5600 takes just minutes to install, fits easily into tight areas, does not require perfectly parallel alignment, and provides reliable and precise position measurements without needing periodic adjustments.

For any high resolution or absolute encoder requirement, the PT5600 delivers the ultimate in flexibility. To order, simply select the measurement range and encoder mounting style—it's that easy! We even supply all the necessary encoder mounting tools and attaching hardware. If you can't find your encoder mounting style or you want us to provide the encoder, please give us a call.

PT5600

Industrial Grade • String Encoder

Outline Drawing

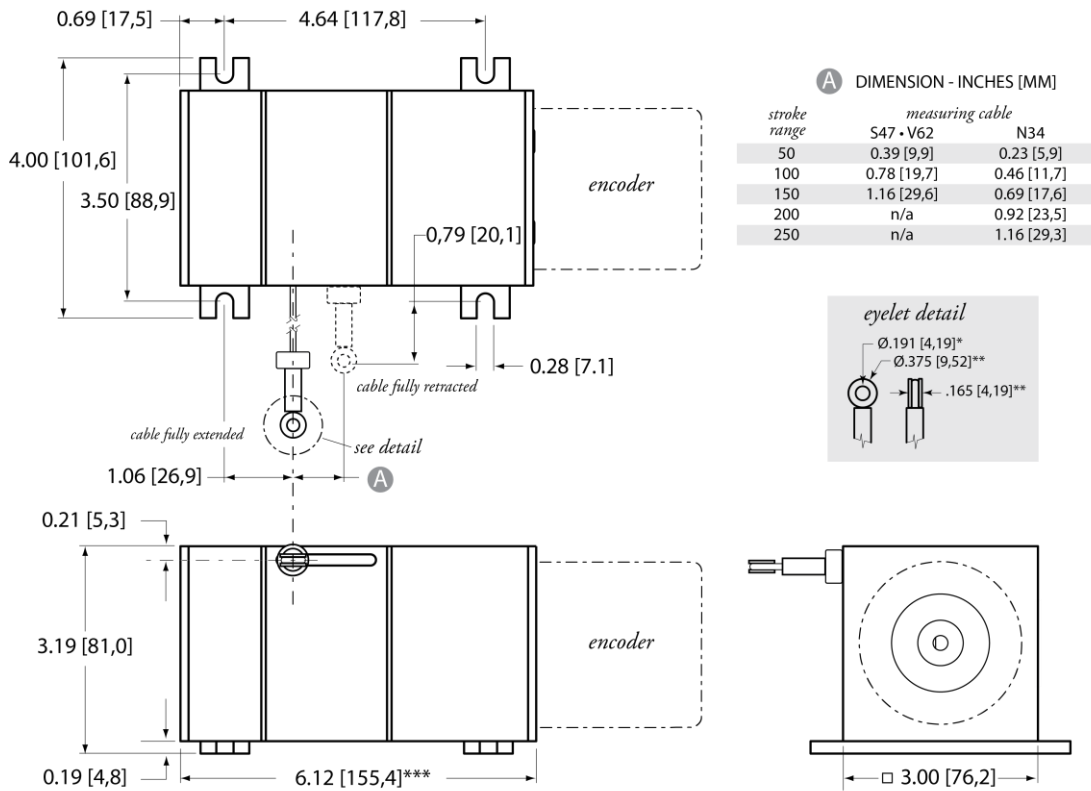

DIMENSIONS ARE IN INCHES [MM]
 tolerances are ± 0.02 in. [± 0.5 mm] unless otherwise noted
 note: *tolerance = $+0.005 -0.001$ [$+0.13 -0.03$] **tolerance = $+0.005 -0.005$ [$+0.13 -0.13$] ***Overall dimension may vary depending on encoder configuration

Ordering Information

Model Number:

PT5600 - _____
 order code: **R** **A** **B** **C**

Sample Model Number:

PT5600 - 100 - N34 - FR - F01

- R** range: 100 inches
- A** measuring cable: .034 nylon-coated stainless
- B** cable exit: front
- C** rotational sensor mounting style: F01 (2.5-in. sq. flange)

» Trying to reorder but can't find your existing model number? Please contact factory for help.

Full Stroke Range:

R order code:	50	100	150	200	250
full stroke range, min:	50 in.	100 in.	150 in.	200 in.	250 in.
cable tension ($\pm 20\%$):	41 ounces	41 ounces	41 ounces	21 ounces	21 ounces

Measuring Cable:

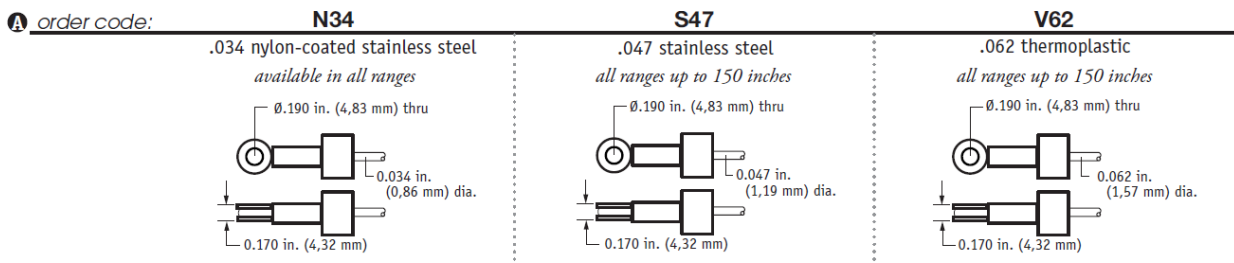

Cable Exit:

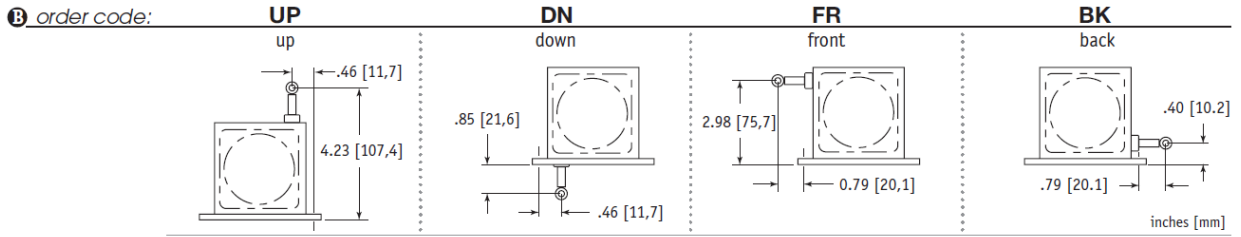

Rotational Sensor Mounting Style:

C order code:

F01	F02	S01	S02	S04
2.5-in. Flange Mount 3/8-inch shaft	2-in. Flange Mount 3/8-inch shaft	Face-Mount 6 mm shaft M4 mounting screws	Face-Mount 10 mm shaft M4 mounting screws	Face-Mount 10 mm shaft M3 mounting screws

Note: If you don't see your encoder style, please contact factory. All encoder types supported.

F01 - 2½-inch Sq. Flange Mount (3/8-inch shaft)

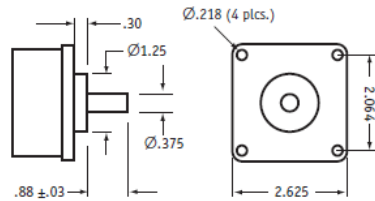

all dimensions are in inches

F02 - 2-inch Sq. Flange Mount (3/8-inch shaft)

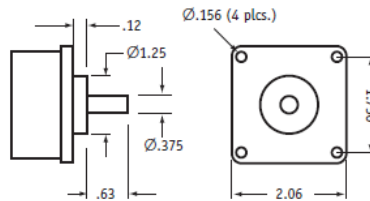

all dimensions are in inches

S01 - Face-Mount (6mm shaft/M4 screws)

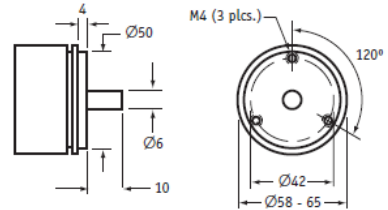

all dimensions are in mm

S02 - Face-Mount (10mm shaft/M4 screws)

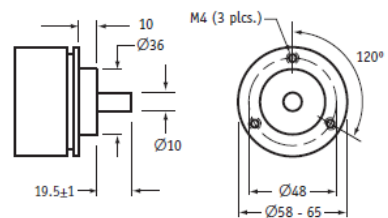

all dimensions are in mm

S04 - Face-Mount (10mm shaft/M3 screws)

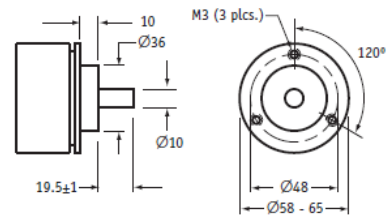

all dimensions are in mm