

7.9" [200 mm]

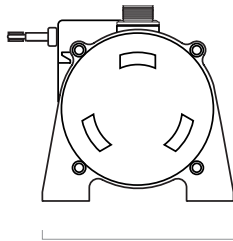

5.3" [135 mm]

The PT9420 is a great value for demanding long-range applications requiring a 4 - 20 mA linear position feedback signal. Sealed to meet NEMA 4 standards, this Cable-Extension Transducer will perform even under the harshest of environmental conditions.

As a member of our innovative family of NEMA-4 rated cable-extension transducers, the PT9420 offers numerous benefits. It installs in minutes, functions properly without perfectly parallel alignment, and when its cable is retracted, it measures only 6".

Output Signal

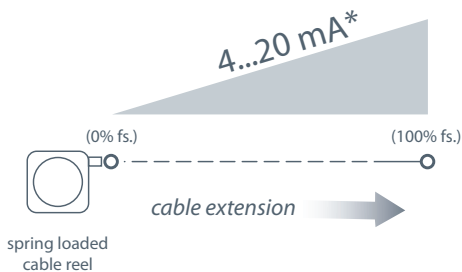

*Optional 3-wire, 0...20mA output signal available.

PT9420

Cable Actuated Sensor

Industrial • 4..20 mA • 0..20mA

Absolute Linear Position to 550 inches (14 meters)

Aluminum or Stainless Steel Enclosure Options

VLS Option to Prevent Free-Release Damage

IP68 / NEMA 6 • Hazardous Area Certification

GENERAL

Full Stroke Range Options

0-75 to 0-550 inches (on this data sheet)

Output Signal Options

4...20 mA (2-wire) and

0...20 mA (3-wire)

Accuracy

± 0.12% full stroke

Repeatability

± 0.05% full stroke

Resolution

essentially infinite

Measuring Cable Options

stainless steel or thermoplastic

Enclosure Material

powder-painted aluminum or 303 stain-

less steel

Sensor

plastic-hybrid precision potentiometer

Potentiometer Cycle Life

≥ 250,000

Max. Retraction Acceleration

see ordering information

Max. Velocity

see ordering information

Weight, Aluminum Enclosure

8 lbs. max.

Weight, Stainless Steel Enclosure

16 lbs. max.

ELECTRICAL

Input Voltage

see ordering information

Input Current

20 mA max.

Maximum Loop Resistance (Load) (loop supply voltage – 8)/0.020

Circuit Protection

38 mA max.

Impedance

100M ohms @ 100 VDC, min.

Output Signal, Zero Adjust

up to 50% of full stroke range

Output Signal, Span Adjust

to 50% of factory set span

ENVIRONMENTAL

Enclosure

NEMA 4/4X/6, IP 67/68

Hazardous Area Certification

see ordering information

Operating Temperature

-40° to 200°F (-40° to 90°C)

Vibration

up to 10 g to 2000 Hz maximum

Thermal Effects, Zero

0.01% f.s./°F, max.

Thermal Effects, Span

0.01%/°F, max.

EMC COMPLIANCE PER DIRECTIVE 89/336/EEC

Emission / Immunity

EN50081-2 / EN50082-2

Fig. 1 - Outline Drawing (18 oz. cable tension option only):

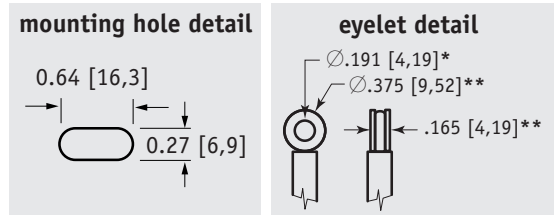
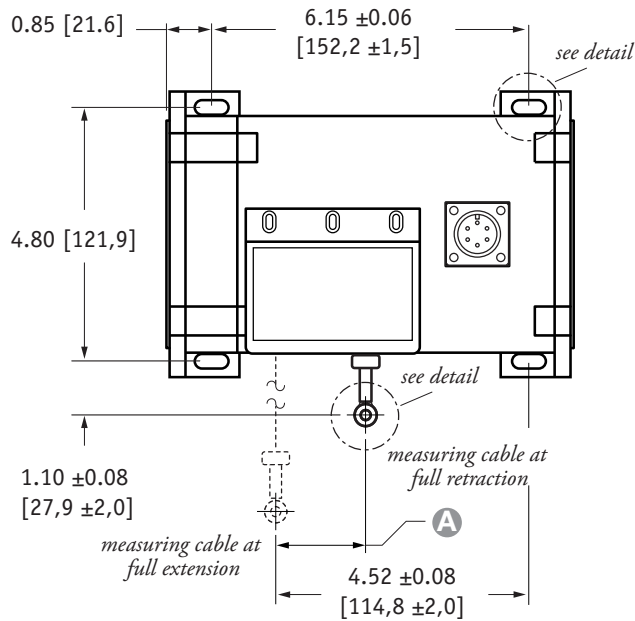

A DIMENSION (INCHES)

RANGE	MEASURING CABLE			
	Ø.031 in.	Ø.034 in.	Ø.047 in.	Ø.062 in.
75	n/a	0.22	0.29	0.37
100	n/a	0.29	0.39	0.49
150	n/a	0.44	0.59	0.73
200	n/a	0.58	0.79	0.98
250	n/a	0.73	0.98	1.22
300	n/a	0.88	1.18	1.47
350	n/a	1.02	1.38	1.71
400	n/a	1.17	1.57	1.96
450	n/a	1.31	1.77	n/a
500	n/a	1.46	1.97	n/a
550	1.61	1.61	n/a	n/a

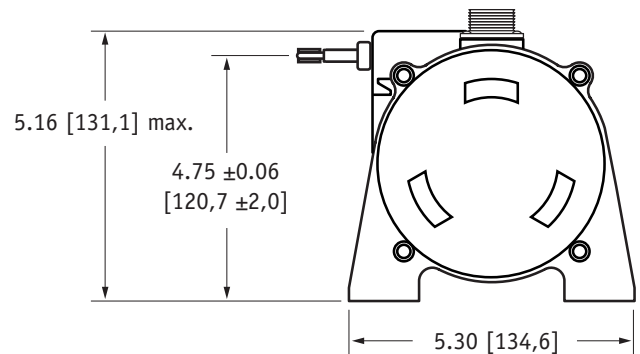
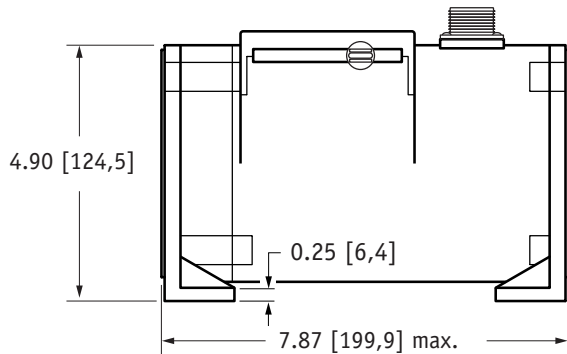

DIMENSIONS ARE IN INCHES [MM]
tolerances are 0.03 IN. [0.5 MM] unless otherwise noted.

* tolerance = +.005 –.001 [+ .13 –.03]
** tolerance = +.005 –.005 [+ .13 –.13]

Ordering Information:

Model Number:

PT9420- _____ **- 1 - 0**
order code: **R** **A** **B** **C** **D** **E** **F** **G**

Sample Model Number:

PT9420 - 0500 - 111 - 1110

- R** range: 500 inches
- A** enclosure/cable tension: aluminum/18 oz.
- B** measuring cable: .034 nylon-coated stainless front
- C** cable exit:
- E** output signal: 4...20 mA, 2-wire
- F** electrical connection: 6-pin plastic connector

Full Stroke Range:

R order code:	0075	0100	0150	0200	0250	0300	0350	0400	0450*	0500*	0550*
full stroke range, min:	75 in.	100 in.	150 in.	200 in.	250 in.	300 in.	350 in.	400 in.	450 in.	500 in.	550 in.

* – 36 oz. cable tension strongly recommended

Ordering Information (cont.):

Enclosure Material and Measuring Cable Tension:

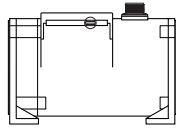
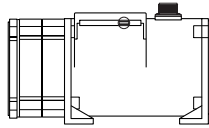
A order code:	1	3	2	4
tension ($\pm 30\%$):	18 oz.		36 oz.	
enclosure material:	<i>powder-painted aluminum</i>	<i>303 stainless steel</i>	<i>powder-painted aluminum</i>	<i>303 stainless steel</i>
max. acceleration:	1 g	1 g	5 g	5 g
max. velocity:	60 inches/sec	60 inches/sec	200 inches/sec	200 inches/sec
		standard housing see fig 1.		dual-spring housing see fig 2.





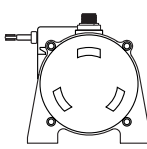
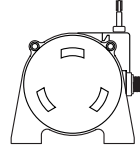
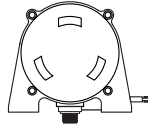
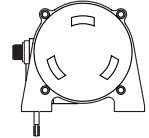

Measuring Cable:

B order code:	1	2	3	4
cable construction:	\varnothing .034-inch nylon-coated stainless steel rope	\varnothing .047-inch bare stainless steel rope	\varnothing .058-inch PVC jacketed vectra fiber rope	\varnothing .031-inch bare stainless steel rope
available ranges:	<i>all ranges</i>	<i>all ranges up to 500 inches</i>	<i>all ranges up to 400 inches</i>	<i>550-inch range only</i>
general use:	indoor	outdoor, debris, high temperature	high voltage or magnetic field	outdoor, debris, high temperature

Cable Exit:

C order code:	1	2	3	4
	front	top	back	down
				

Output Signals:

D order code:	1	2	3	4	5*	6*
output signal options:	4...20 mA 	20...4 mA 	0...20 mA 	20...0 mA 	4...20 mA 	20...4 mA 
sensitivity:	16 mA/full stroke $\pm 0.25\%$		20 mA/full stroke $\pm 0.25\%$		16 mA/full stroke $\pm 0.25\%$	
wiring configuration:	2 - wire		3 - wire		2 - wire	
input voltage:	8 - 34 vdc		14 - 29 vdc		14 - 32 vdc	
hazardous area certification:			not certified		CSA	

Output Signal Example:

ordercode = **1** = 4...20 mA \rightarrow

4 mA = 

20 mA = 



Hazardous Area Certification:

CSA Standard 22.2
Class 1
Groups A, B, C and D

**IMPORTANT: intrinsically safe when powered from a CSA certified zener barrier rated 28 VDC max, 110 mA max per installation drawing#677984*

Ordering Information (cont.):

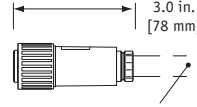
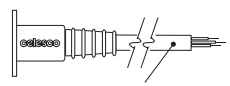
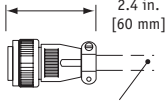
Electrical Connection:

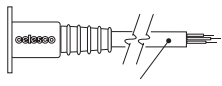
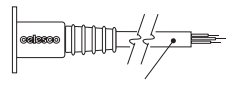
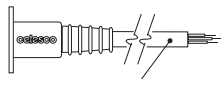
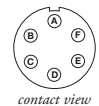
<p>1</p> <p>order code:</p> <p>6-pin plastic connector w/mating plug IP 67, NEMA 4X**,6</p>  <p>3.0 in. [78 mm]</p> <p>1/2 - 5/16" [14 - 8 mm] cable dia. 16 AWG max conductor size connector: MS3102E-14S-6P mating plug: MS3106E-14S-6S</p>	<p>2</p> <p>10-ft. [3 M] waterproof cable IP 67, NEMA 4X**, 6</p>  <p>10 ft. x 0.4-in. dia. [3 M x 10 mm dia.] 18 AWG, type SJTOW</p>	<p>3</p> <p>6-pin metal connector w/mating plug IP 65, NEMA 4</p>  <p>2.4 in. [60 mm]</p> <p>3/8-in. [9 mm] max cable dia. 16 AWG max conductor size connector: MS3102E-14S-6P mating plug: MS3106E-14S-6S</p>	<p>4</p> <p>25-ft. [7.5 M] instrumentation cable IP 67, NEMA 6</p>  <p>25 ft. x 0.2-in. dia. [7,5 M x 5 mm dia.] 24 AWG, shielded</p>																																										
<p>5</p> <p>order code:</p> <p>100-ft. [30 M] waterproof cable IP 67, NEMA 4X**,6</p>  <p>100 ft. x 0.4-in. dia. [30 M x 10 mm dia.] 18 AWG, type SJTOW</p>	<p>6</p> <p>10-ft. [3 M] pressure tested* waterproof cable IP 68, NEMA 4X**, 6P</p>  <p>10 ft. x 0.4-in. dia. [3 M x 10 mm dia.] 18 AWG, type SJTOW</p>	<p>7</p> <p>100-ft. [30 M] pressure tested* waterproof cable IP 68, NEMA 4X**, 6P</p>  <p>100 ft. x 0.4-in. dia. [30 M x 10 mm dia.] 18 AWG, type SJTOW</p>																																											
<p>6-pin Mating Plug</p> <table border="1"> <thead> <tr> <th>pin</th> <th>2-wire</th> <th>3-wire</th> </tr> </thead> <tbody> <tr> <td>A</td> <td>8...34 vdc***</td> <td>14...29 vdc common</td> </tr> <tr> <td>B</td> <td>4...20 mA out</td> <td>0...20 mA out</td> </tr> <tr> <td>C</td> <td>-</td> <td>-</td> </tr> <tr> <td>D</td> <td>case ground</td> <td>-</td> </tr> </tbody> </table>  <p>contact view</p>		pin	2-wire	3-wire	A	8...34 vdc***	14...29 vdc common	B	4...20 mA out	0...20 mA out	C	-	-	D	case ground	-	<p>Waterproof Cable</p> <table border="1"> <thead> <tr> <th>color code</th> <th>2-wire</th> <th>3-wire</th> </tr> </thead> <tbody> <tr> <td>WHITE</td> <td>8...34 vdc***</td> <td>14...29 vdc common</td> </tr> <tr> <td>BLACK</td> <td>4...20 mA out</td> <td>0...20 mA out</td> </tr> <tr> <td>GREEN</td> <td>case ground</td> <td>-</td> </tr> </tbody> </table> <p>Instrumentation Cable</p> <table border="1"> <thead> <tr> <th>color code</th> <th>2-wire</th> <th>3-wire</th> </tr> </thead> <tbody> <tr> <td>RED</td> <td>8...34 vdc***</td> <td>14...29 vdc common</td> </tr> <tr> <td>BLACK</td> <td>4...20 mA out</td> <td>n/a</td> </tr> <tr> <td>WHITE</td> <td>n/a</td> <td>n/a</td> </tr> <tr> <td>GREEN</td> <td>case ground</td> <td>0...20 mA out</td> </tr> </tbody> </table>		color code	2-wire	3-wire	WHITE	8...34 vdc***	14...29 vdc common	BLACK	4...20 mA out	0...20 mA out	GREEN	case ground	-	color code	2-wire	3-wire	RED	8...34 vdc***	14...29 vdc common	BLACK	4...20 mA out	n/a	WHITE	n/a	n/a	GREEN	case ground	0...20 mA out
pin	2-wire	3-wire																																											
A	8...34 vdc***	14...29 vdc common																																											
B	4...20 mA out	0...20 mA out																																											
C	-	-																																											
D	case ground	-																																											
color code	2-wire	3-wire																																											
WHITE	8...34 vdc***	14...29 vdc common																																											
BLACK	4...20 mA out	0...20 mA out																																											
GREEN	case ground	-																																											
color code	2-wire	3-wire																																											
RED	8...34 vdc***	14...29 vdc common																																											
BLACK	4...20 mA out	n/a																																											
WHITE	n/a	n/a																																											
GREEN	case ground	0...20 mA out																																											

Notes: { * -Test pressure: 100 feet [30 meters] H₂O (40 PSID); Test Medium: Air; Duration: 2 hours.
** -NEMA 4X applies to stainless steel enclosure only.
*** -14-32 VDC for hazardous area option.

Output Signal Selection (not available with intrinsically safe option):

output signal	switch setting	signal board
0...20 mA or 4...20 mA		
20...0 mA or 20...4 mA		

dip-switch location

The output signal direction can be reversed at any time by simply changing the dip-switch settings found on the internal signal board. After the settings have been changed, adjustment of the Zero and Span trimpots will be required to precisely match signal values to the beginning and end points of the stroke.

To gain access to the signal board, remove four Allen-Head Screws and remove end cover bracket.

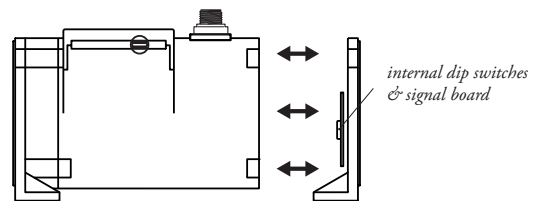

Caution! Do Not Remove Spring-Side End Cover
Removing spring-side end cover could cause spring to become unseated and permanently damaged.

Fig. 2 – Outline Drawing (36 oz. cable tension only)

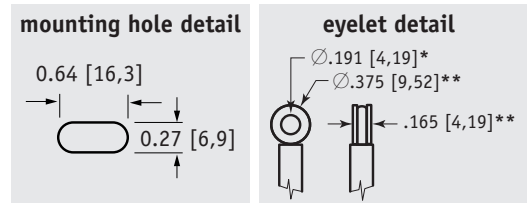
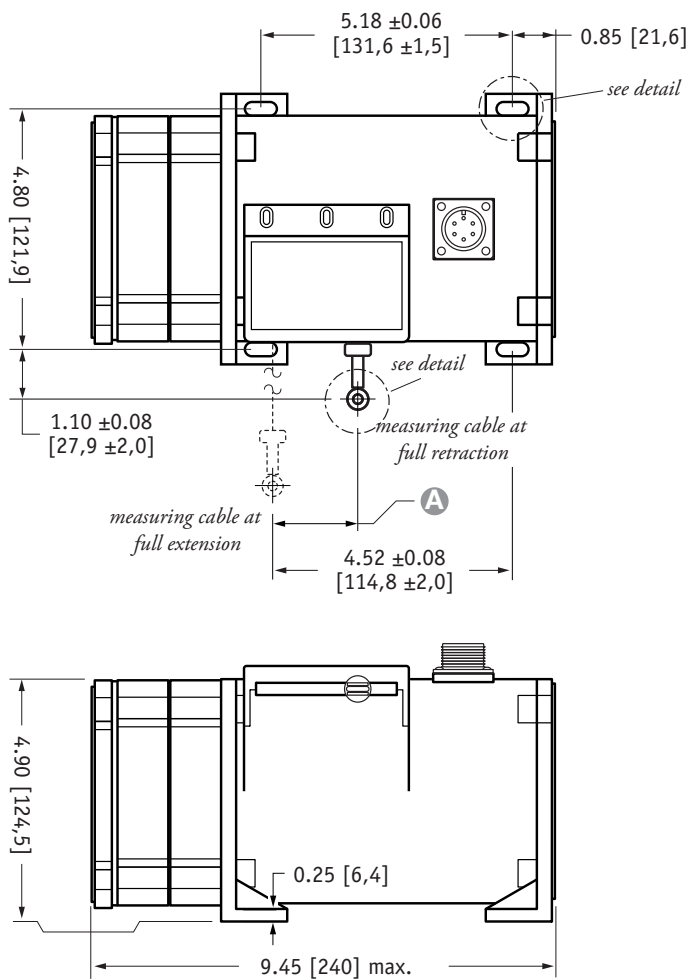

A DIMENSION (INCHES)

RANGE	MEASURING CABLE			
	Ø.031 in.	Ø.034 in.	Ø.047 in.	Ø.062 in.
75	n/a	0.22	0.29	0.37
100	n/a	0.29	0.39	0.49
150	n/a	0.44	0.59	0.73
200	n/a	0.58	0.79	0.98
250	n/a	0.73	0.98	1.22
300	n/a	0.88	1.18	1.47
350	n/a	1.02	1.38	1.71
400	n/a	1.17	1.57	1.96
450	n/a	1.31	1.77	n/a
500	n/a	1.46	1.97	n/a
550	1.61	1.61	n/a	n/a

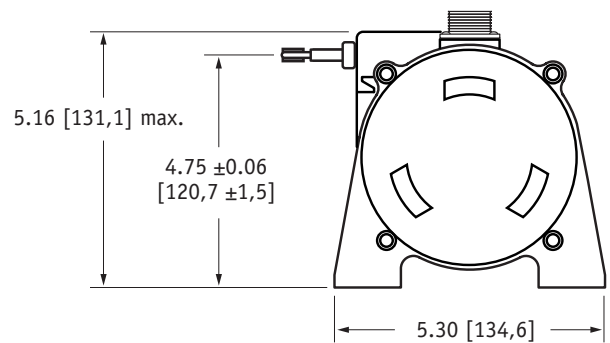

DIMENSIONS ARE IN INCHES [MM]
tolerances are 0.03 IN. [0.5 MM] unless otherwise noted.

* tolerance = +.005 -.001 [+.13 -.03]
** tolerance = +.005 -.005 [+ .13 -.13]

VLS Option - Free Release Protection

Our Velocity Limiting System (VLS) is an option for PT9000 Series cable extension transducers that limits cable retraction to a safe 40 to 55 inches per second for the single spring option and 40 to 80 inches per second for the higher tension dual spring option.

The VLS option prevents the measuring cable from ever reaching a damaging velocity during an accidental free release. This option is ideal for mobile applications that require frequent cable disconnection and reconnection. It prevents expensive unscheduled downtime due to accidental cable mishandling or attachment failure.

How To Configure Model Number for VLS Option:

1. using guide below, select PT9420 model **PT9420-0100-111-1110**
2. remove "PT" from the model number ~~PT~~ **9420-0100-111-1110**
3. add "VLS" **VLS + 9420-0100-111-1110**
4. completed model number! **VLS9420-0100-111-1110**

VLS9420- _____ - _____ - **1** _____ **0**

0075	1	1	1	1	1
thru	2	2	2	2	2
0550	3	3	3	3	3
	4	4	4	4	4
				5	5
				6	6
					7

= available options.