

## PT9600

### Cable Actuated Encoder Reel

**Converts ANY Rotary Encoder to a Linear Position Sensor**

**Linear Stroke Range up to 550 inches (14 m)**

**Mates Virtually ANY Customer Supplied Encoder**

**Factory Supplied Encoder Available**

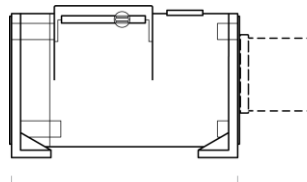

7.9" [200 mm]

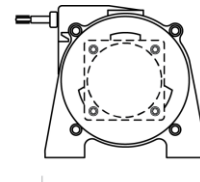

5.3" [135 mm]

Our unique string encoder module mates to virtually any encoder, giving you a cost-effective long-range linear position measurement solution that precisely fits your requirements.

This modular approach delivers the ultimate in flexibility. To order, simply select the measurement range, the cable tension and encoder mounting style—it's that easy! We even supply all the necessary encoder mounting tools and attaching hardware. If you can't find your encoder mounting style or you want us to provide the encoder, please give us a call.

#### General

<b>Full Stroke Range</b>	0-75 to 0-550 inches
<b>Motion Conversion Ratio</b>	12.6 inches per turn, see ordering information
<b>Accuracy</b>	the lesser of $\pm 0.02\%$ f.s. or $\pm 0.04\%$ measurement $\pm 1/2$ pulse
<b>Accuracy, best</b>	not less than 0.001 in. (0.03mm)
<b>Repeatability</b>	$\pm 0.02\%$ of measurement $\pm 1/2$ pulse
<b>Measuring Cable Options</b>	see ordering information
<b>Module Material Options</b>	powder-painted aluminum or stainless
<b>Encoder Coupling</b>	aluminum flexible coupling
<b>Maximum Allowable Rotational Sensor Torque</b>	1.0 in.-lbs.
<b>Maximum Retraction Acceleration</b>	see ordering information
<b>Maximum Velocity</b>	see ordering information
<b>Weight, Aluminum (Stainless Steel) Enclosure</b>	8 lbs. (16 lbs.) max.

#### Environmental

<b>Operating Temperature</b>	-40° to 200°F (-40° to 90°C)
------------------------------	------------------------------

**PT9600**

Cable Reel • String Encoder

Fig. 1 – Outline Drawing (18 oz. cable tension only)

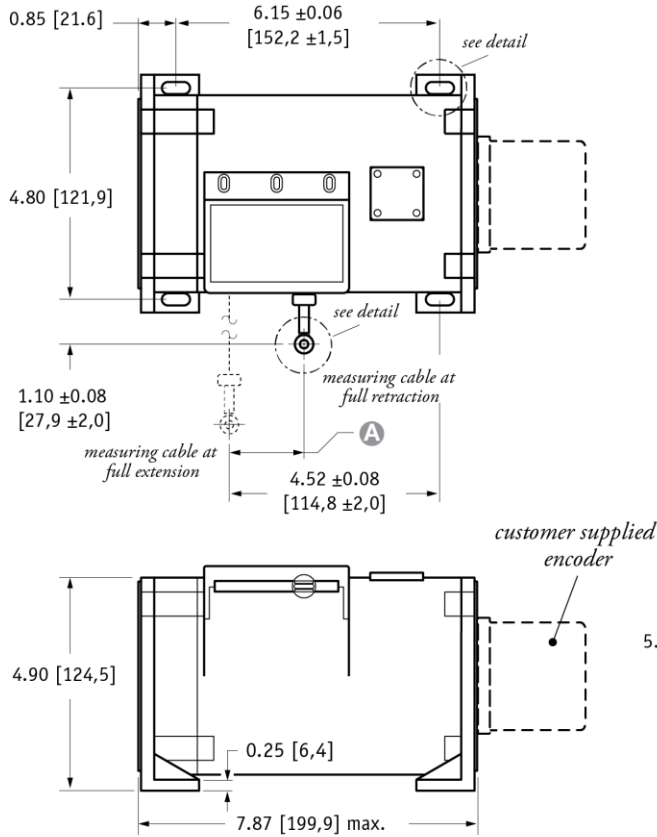

DIMENSIONS ARE IN INCHES [MM]  
tolerances are 0.03 IN. [0.5 MM] unless otherwise noted.

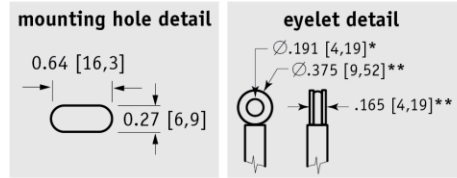

**A DIMENSION (INCHES)**

MEASURING CABLE				
RANGE	Ø.031 in.	Ø.034 in.	Ø.047 in.	Ø.062 in.
75	n/a	0.22	0.29	0.37
100	n/a	0.29	0.39	0.49
150	n/a	0.44	0.59	0.73
200	n/a	0.58	0.79	0.98
250	n/a	0.73	0.98	1.22
300	n/a	0.88	1.18	1.47
350	n/a	1.02	1.38	1.71
400	n/a	1.17	1.57	1.96
450	n/a	1.31	1.77	n/a
500	n/a	1.46	1.97	n/a
550	1.61	1.61	n/a	n/a

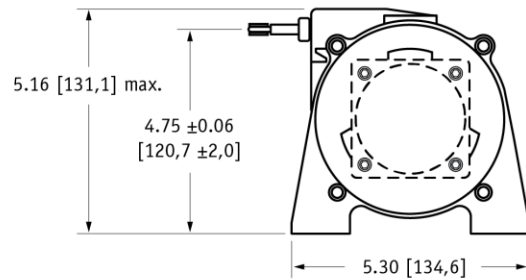

\* tolerance = +.005 -.001 [+,.13 -.03]  
\*\* tolerance = +.005 -.005 [+,.13 -.13]

**VLS Option - Free Release Protection**

The patented Celesco Velocity Limiting System (VLS) is an option for PT9000 Series cable extension transducers that limits cable retraction to a safe 40 to 55 inches per second for the single spring option and 40 to 80 inches per second for the higher tension dual spring option.

The VLS option prevents the measuring cable from ever reaching a damaging velocity during an accidental free release. This option is ideal for mobile applications that require frequent cable disconnection and reconnection. It prevents expensive unscheduled downtime due to accidental cable mishandling or attachment failure.

1. using guide below, select PT9600 model **PT9600-0100-111-F01**
2. remove "PT" from the model number **~~PT~~ 9600-0100-111-F01**
3. add "VLS" **VLS + 9600-0100-111-F01**
4. completed model number! **VLS9600-0100-111-F01**

**VLS9600-**

	<b>B</b>	<b>A</b>	<b>B</b>	<b>C</b>	<b>D</b>
0075	1	1	1	F01	
thru	2	2	2	F02	
0550	3	3	3	S01	
	4	4	4	S02	
				S04	

■ = available options.

# PT9600

Cable Reel • String Encoder

## Ordering Information

### Model Number:

**PT9600**- \_\_\_\_\_  
*order code:*                    **R**                    **A**                    **B**                    **C**                    **D**

### Sample Model Number:

**PT9600 - 0200 - 111 - F01**

- R** range: 200 inches
- A** enclosure / cable tension: aluminum / 18 oz.
- B** measuring cable: .034 nylon-coated stainless
- C** cable exit: front
- D** rotational sensor mounting style: F01 (2.5-in. sq. flange)

### Full Stroke Range:

<b>R</b> order code:	<b>0075</b>	<b>0100</b>	<b>0150</b>	<b>0200</b>	<b>0250</b>	<b>0300</b>	<b>0350</b>	<b>0400</b>	<b>0450*</b>	<b>0500*</b>	<b>0550*</b>
full stroke range, min:	75 in.	100 in.	150 in.	200 in.	250 in.	300 in.	350 in.	400 in.	450 in.	500 in.	550 in.

\* -36 oz. cable tension strongly recommended

### Enclosure / Measuring Cable Tension:

<b>A</b> order code:	<b>1</b>	<b>3</b>	<b>2</b>	<b>4</b>
tension (±30%):	18 oz.		36 oz.	
enclosure material:	<i>powder-painted aluminum</i>	<i>303 stainless steel</i>	<i>powder-painted aluminum</i>	<i>303 stainless steel</i>
max. acceleration:	1 g	1 g	5 g	5 g
max. velocity:	60 inches/sec	60 inches/sec	200 inches/sec	200 inches/sec

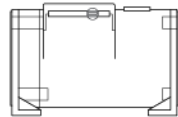

standard housing  
see fig 1.

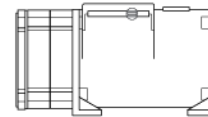

dual-spring housing  
see fig 2.

### Measuring Cable/ Conversion Ratio:

<b>B</b> order code:	<b>1</b>	<b>2</b>	<b>3</b>	<b>4</b>	
cable construction:	Ø.034-inch nylon-coated stainless steel rope	Ø.047-inch bare stainless steel rope	Ø.058-inch PVC jacketed vectra fiber rope	Ø.031-inch bare stainless steel rope	
available ranges:	<i>all ranges</i>	<i>all ranges up to 500 inches</i>	<i>all ranges up to 400 inches</i>	<i>550-inch range only</i>	
general use:	indoor	outdoor, debris, high temperature	high voltage or magnetic field	outdoor, debris, high temperature	
conversion ratio {	aluminum enclosure:	1 turn = 12.673 ± 0.016 in.	1 turn = 12.714 ± 0.016 in.	1 turn = 12.755 ± 0.016 in.	1 turn = 12.664 ± 0.016 in.
	stainless enclosure:	1 turn = 12.579 ± 0.022 in.	1 turn = 12.620 ± 0.022 in.	1 turn = 12.661 ± 0.022 in.	1 turn = 12.569 ± 0.022 in.

### Cable Exit:

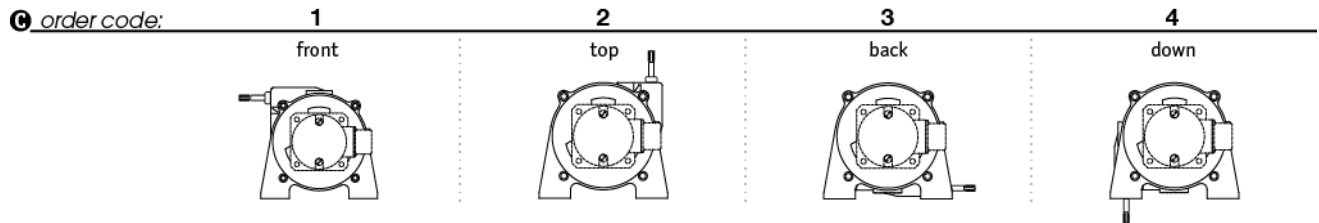

**Rotational Sensor Mounting Style:**

① order code:	F01	F02	S01	S02	S04
	2.5-in. Flange Mount 3/8-inch shaft	2-in. Flange Mount 3/8-inch shaft	Face-Mount 6 mm shaft M4 mounting screws	Face-Mount 10 mm shaft M4 mounting screws	Face-Mount 10 mm shaft M3 mounting screws

*Note: If you don't see your encoder style, please contact factory. All encoder types supported.*

**F01 - 2½-inch Sq. Flange Mount (3/8-inch shaft)**

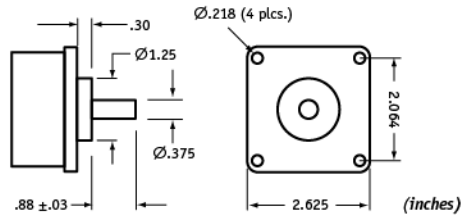

**F02 - 2-inch Sq. Flange Mount (3/8-inch shaft)**

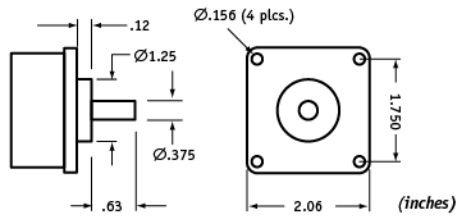

**S01 - Face-Mount (6mm shaft/M4 screws)**

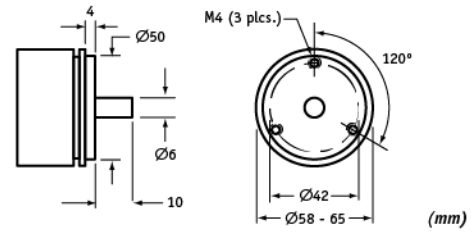

**S02 - Face-Mount (10mm shaft/M4 screws)**

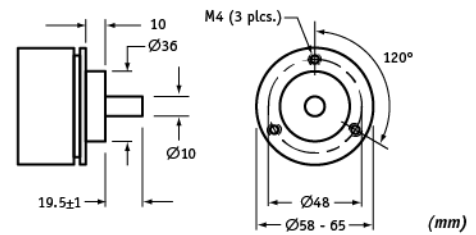

**S04 - Face-Mount (10mm shaft/M3 screws)**

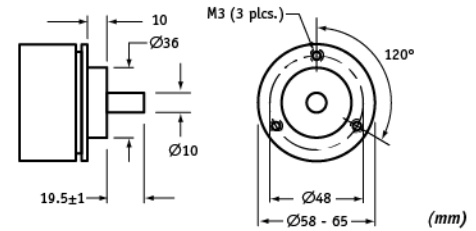
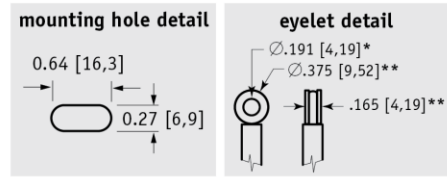
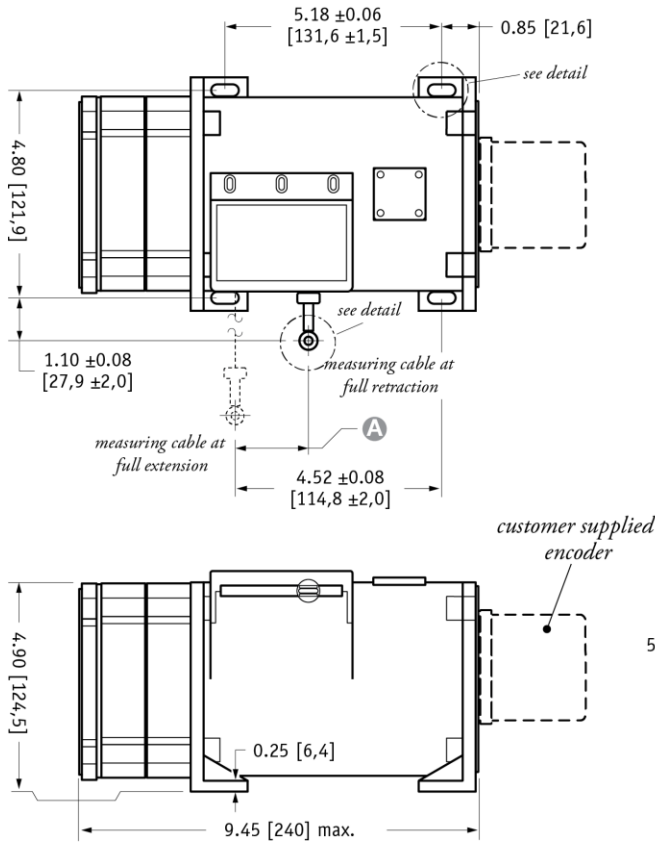
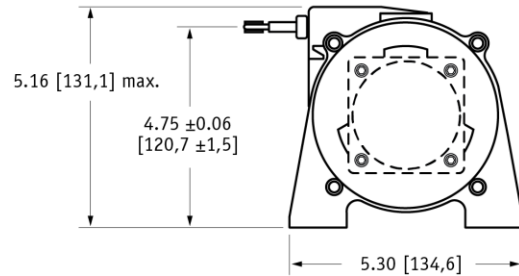

Fig. 2 – Outline Drawing (36 oz. cable tension only)



**A DIMENSION (INCHES)**

MEASURING CABLE				
RANGE	∅.031 in.	∅.034 in.	∅.047 in.	∅.062 in.
75	n/a	0.22	0.29	0.37
100	n/a	0.29	0.39	0.49
150	n/a	0.44	0.59	0.73
200	n/a	0.58	0.79	0.98
250	n/a	0.73	0.98	1.22
300	n/a	0.88	1.18	1.47
350	n/a	1.02	1.38	1.71
400	n/a	1.17	1.57	1.96
450	n/a	1.31	1.77	n/a
500	n/a	1.46	1.97	n/a
550	1.61	1.61	n/a	n/a



DIMENSIONS ARE IN INCHES [MM]  
tolerances are 0.03 IN. [0.5 MM] unless otherwise noted.

\* tolerance = +.005 -.001 [+.13 -.03]  
\*\* tolerance = +.005 -.005 [+.13 -.13]